



Laser Distance Measure
Model No. 40-6005



Instruction Manual

Congratulations on your choice of this Laser Distance Measure. We suggest you read this instruction manual thoroughly before using the instrument. Save this instruction manual for future use.

This is a Class II laser tool and is manufactured to comply with CRF 21, parts 1040.10 and 1040.11 as well as international safety rule IEC 285. The laser also complies with EMC Test according to EN61000-6-3; 2001+A11:2004, EN 6100-6-1:2011, EN 6100-4-2, EN 61000-4-3, EN 60825, FCC Test according to PART 15.

Table of Contents

1.Kit Contents	pg. 2	5.Start Up - Battery Installation Instructions	pg. 7
2.Safety Information . . .	pg. 2-3	6.Using the Product . .	pg. 8-24
3.Location/Content of Warning Labels	pg. 3	7.Technical Specifications	pg. 25
4.Location of Parts/ Components	pg. 4-5	8.Product Warranty. . . .	pg. 26
		9.Product Registration . .	pg. 27

1. Kit Contents

Description for Model 40-6005

	Qty.
Laser Distance Measure	1
Wrist Strap	1
“AA” Alkaline Batteries	2
Soft-Sided Pouch	1
Instruction Manual	1

2. Safety Instructions

Please read and understand all of the following instructions, prior to using this tool. Failure to do so, may result in bodily injury.

CAUTION!

Class II Laser Product
Max. Power Output: $\leq 1\text{mW}$
Wavelength: 640-660nm

**THIS TOOL EMITS LASER RADIATION.
DO NOT STARE INTO BEAM.
AVOID DIRECT EYE EXPOSURE.**



**ATTENTION****IMPORTANT**

- Read all instructions prior to operating this laser tool. Do not remove any labels from tool.
- Do not stare directly at the laser beam.
- Do not project the laser beam directly into the eyes of others.
- Do not set up laser tool at eye level or operate the tool near a reflective surface as the laser beam could be projected into your eyes or into the eyes of others.
- Do not place the laser tool in a manner that may cause someone to unintentionally stare into the laser beam. Serious eye injury may result.
- Do not operate the tool in explosive environments, i.e. in the presence of gases or flammable liquids.
- Keep the laser tool out of the reach of children and other untrained persons.
- Do not attempt to view the laser beam through optical tools such as telescopes as serious eye injury may result.
- Always turn the laser tool off when not in use or left unattended for a period of time.
- Remove the battery when storing the tool for an extended time (more than 3 months) to avoid damage to the tool should the batteries deteriorate.
- Do not attempt to repair or disassemble the laser tool. If unqualified persons attempt to repair this tool, warranty will be void.
- Use only original Johnson® parts and accessories purchased from your Johnson® authorized dealer.

3. Location/Content of Warning Labels





4. Location of Part/Components

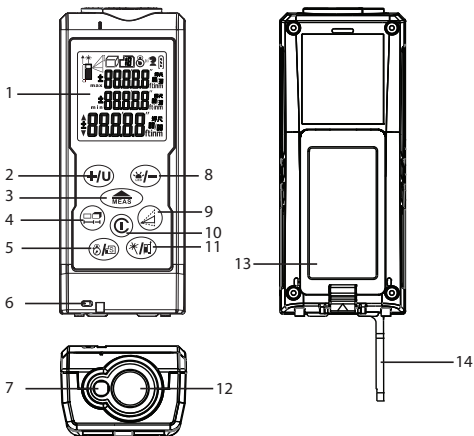

- | | |
|--|--|
| 1. LCD Display | 7. Laser Emitting Window |
| 2. Add/Unit of Measure | 8. Subtract/Back-Light |
| 3. Measure Button | 9. Indirect Measurement/Pythagoras |
| 4. Measure Function | 10. Power Button/Clear/Escape |
| Area | 11. Measuring Reference Position/
Continuous Laser Mode |
| Volume | 12. Receiver Window |
| Stake-Out | 13. Battery Cover |
| 5. Countdown Measure/
Memory Recall | 14. Corner Measurement
Extension Piece |
| 6. Wrist Strap Bracket | |



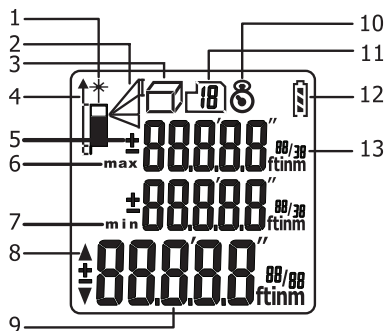

- | | |
|-----------------------------------|-------------------------------|
| 1. Active Laser Indicator | 5. Add and Subtract |
| 2. Indirect Measuring | 6. Maximum Display |
| ▽ Single Pythagoras | 7. Minimum Display |
| ▾ Double Pythagoras | 8. Stake Direction Indicator |
| ▹ Double Pythagoras | 9. Main Screen and |
| (Partial Height) | Units of Measure |
| 3. Measuring Function | 10. Countdown Measuring Timer |
| □ Area Measuring | 11. Memory Counter |
| ▣ Volume Measuring | 12. Battery Status |
| 4. Measurement Reference Position | 13. Sub-Screen and Units |
| | of Measure |



Measuring Reference

Range

Range is specified between a minimum 2-inches to a maximum of 230-feet with an accuracy of 1/16". Longer ranges will be found by the instrument but a variance in the accuracy may exist. At night or dusk the range may be greater than during daylight or if the target has poor reflective properties.

Target Surfaces

Measuring errors may occur when aiming at surfaces composed of colorless liquids (e.g. water), glass, Styrofoam or similar semi-permeable surfaces. Aiming at high gloss surfaces may deflect the laser beam and lead to measurement errors.

Hazards of Use



Be aware that errors in distance measurements may occur if the instrument is defective or has been dropped, been misused or modified.

Note

Conduct periodic test measurements to ensure the instrument is measuring accurately and consistently. This is most important if the instrument has been exposed to abnormal use. Always confirm accuracy before and during important measurements. Keep the laser distance measure optic clean and inspect for damage.



5. Start Up - Battery Installation

1. Remove battery compartment lid.
2. Insert 2-“AA” batteries observing correct polarity.
3. Close battery compartment lid.
4. Battery status will be shown in start up screen.
5. When the  icon appears there are approximately 1,000 measurements remaining.
6. Replace batteries when the  icon flashes on the screen.
7. Remove old batteries and replace with new “AA” alkaline batteries following steps 1-3 above.

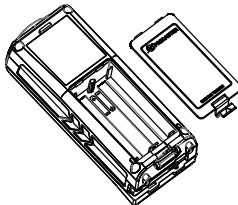

Note

Use only alkaline batteries. If the instrument will not be used for an extended time, remove the batteries to protect against corrosion.

Power Button

Press  Power Button to power up.

Press and hold  Power Button to power off.

Automatic Shutoff

Laser will turn off after 30 seconds

Unit will turn off after 3 minutes of inactivity



6. Using the Product

Tip: Place a white sheet of paper over the targeted measuring surface if error message Err02 occurs to improve the return signal.

Measuring

Measuring Modes

Your Laser Distance Measure has four measuring modes:

Length

Area/Square

Volume/Cube

Indirect/Pythagoras

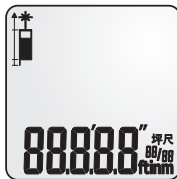

Units of Measure

This instrument has seven units of measure. The desired unit of measure can be set by pressing and holding **+ / U** for two seconds. The main screen will display square feet/square meters or cubic feet/cubic meters in a decimal format when calculating area and volume. The following units can be set:

	Distance	Area	Volume
1.	0.000 m	0.000 m ²	0.000 m ³
2.	0.00 ft	0.00 ft ²	0.00 ft ³
3.	0'0" 1/32	0.00 ft ²	0.00 ft ³
4.	0.00 in	0.00 ft ²	0.00 ft ³
5.	0 1/32 in	0.00 ft ²	0.00 ft ³
6.	0 1/16 in	0.00 ft ²	0.00 ft ³
7.	0 1/8 in	0.00 ft ²	0.00 ft ³



Measurement Reference Position

Be sure to adjust the measuring reference position prior to engaging a measuring calculation mode. Press and release  to scroll through the reference point options

Front

Rear

Corner Extension Piece

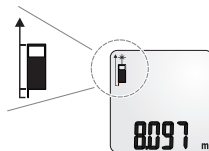

Single Distance Measuring

Press  to turn power on.

Direct Laser Beam to Target.

Press and release .

Keep unit still until measurement has been recorded. Laser beam will shut off once measurement has been recorded.

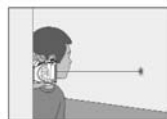

Recorded measurements (up to 20 measurements will be stored automatically and available for recall, see Memory Recall page 21).

Press and release  to clear screen.

Press and hold  to power down unit



Measuring with Countdown Timer

Press and release .

 icon will appear on screen with default setting of three second countdown timer.

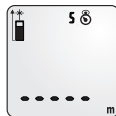

Press and release  to activate laser (if inactive.)

Direct the laser beam towards the target and hold steady.

Press and release  to activate the countdown timer.

Measurement will be recorded on screen.

Repeat these steps for each measurement. Countdown measuring may be used during any measuring function (e.g. Pythagorean, area, volume, etc).

To extend the time from three seconds press and release  until you reach desired time. Timer can be set up to 15 seconds.

Adding or Subtracting

Press and release the  button to activate laser.

Press and release the  button to record first measurement.

Press and release  (first measurement moves to sub value position on screen and a "+" sign temporarily appears).

Press and release the  button to activate laser. (If inactive.)

Press and release the  button to record second measurement.

Press and release  to add measurement 1 (stored in sub value position) and measurement 2 together.





To add another measurement to sum (repeat same measurement sequence) to tally.

To subtract a value in the tally sequence press  button.

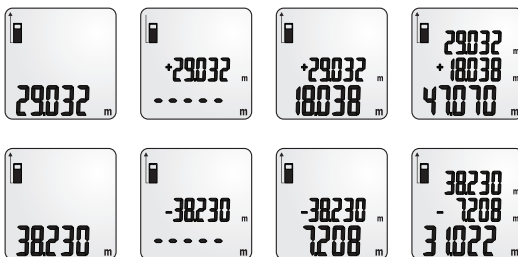

This laser distance measure has the capability to add or subtract area, volume or indirect measurement calculations. For example, if you need the square footage of four rooms this instrument will allow you to add each area calculation together to sum the dimensions of the four rooms. The same holds true for volume or indirect measurement modes. Please see each respective measurement section for the step-by-step instructions.







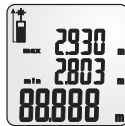
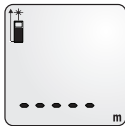

Continuous Measuring

This mode will take continuous measurements as you move closer or further away from the target. Minimum working range is 2-inches. Maximum working range is 230-feet.



Press and hold the  button to activate continuous measuring mode.

To pause Continuous Measuring mode press  or .

To resume Continuous Measuring mode press  or to exit Continuous Measuring mode press .

Minimum / Maximum Measurements

As the laser beam is scanned across the measuring surface, the maximum and minimum distance is simultaneously recorded in the sub value positions on the screen as the laser is scanning the targeted surface.

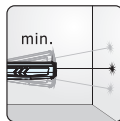



Area Measurement (Square²)

Press  Power Button to turn power on.

Press  button to enter Area mode.

A rectangle icon will appear on the upper left side of screen.

Observe flashing line for each required measurement (Length & Width).

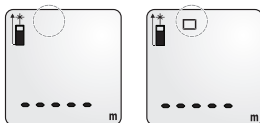

Follow flashing line instructions on screen to measure width & length.

Press and release  button to record measurements.

Area calculation will be presented in sub value position at top of screen.

Note: Unit of measure for area calculation will be displayed in decimal form in square feet or square meters on main screen.

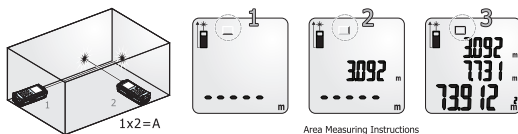

To tally (or sum) the Area calculations of multiple rooms use the following steps:

Suggestions:

Be sure you have the desired unit of measure selected.

For better visibility press and hold the backlight button  to activate the backlight.







It is recommended that you test this function prior to taking important measurements. Simply write down each Area calculation on a piece of paper and add (or subtract) the Area calculations along with the Laser Distance Measure. This will familiarize you with the process of how the calculations are determined.

Follow the Area measurement instructions above to enter Area mode.

Once the first Area calculation is taken it will be displayed in the bottom row on the LCD screen.

Press and release the  button.

Upon pressing the  button the LCD screen will be cleared however the Area calculation is stored.

The Area mode will remain active on the LCD screen.

Take the second room Area dimensions.

When the Area calculation appears in the bottom row press and release the  button again.

You will now see the previous Area calculation at the top row being added to the most recent Area calculation in the middle row.

The sum of both Area calculations will be displayed in the bottom row.

Follow this sequence to continue tallying additional room dimensions.

To subtract an Area measurement simply press and release the  button during the sequence and that value will be deducted from the total.





Volume Measurement (Cube³)

Press  Power Button to turn power on.

Press and release  button two times.

A 3- dimensional rectangle icon will appear on the upper left side of screen. Observe flashing line for each required measurement (Length, Height & Width).



Follow flashing line instructions on screen to measure length, width & height. Press and release  button to record measurements. Volume calculation will be presented in sub value position at top of screen.

Note: Unit of measure for cube calculation will be displayed in decimal form in cubic feet or cubic meters on main screen.

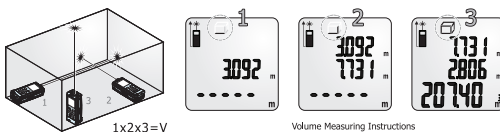

To tally (or sum) the Volume calculations of multiple rooms use the following steps:

Suggestions:

Be sure you have the desired unit of measure selected.







For better visibility press and hold the backlight button  to activate the backlight.

It is recommended that you test this function prior to taking important measurements. Simply write down each Volume calculation on a piece of paper and add (or subtract) the Volume calculations along with the Laser Distance Measure. This will familiarize you with the process of how the calculations are determined.

Follow the Volume measurement instructions above to enter Volume mode.

Once the first Volume calculation is taken it will be displayed in the bottom row on the LCD screen.

Press and release the  button.

Upon pressing the  button the LCD screen will be cleared however the Volume calculation is stored.

The Volume mode will remain active on the LCD screen.

Take the second Volume dimensions.

When the Volume calculation appears in the bottom row press and release the  button again.

You will now see the previous Volume calculation at the top row being added to the most recent Volume calculation in the middle row.

The sum of both Volume calculations will be displayed in the bottom row.

Follow this sequence to continue tallying additional room dimensions.

To subtract a Volume measurement simply press and release the  button during the sequence and that value will be deducted from the total.





Indirect Measurements (Pythagorean Methods)

All Calculations are based on Pythagorean Theorem $a^2+b^2=c^2$.

This function allows for the measurement of hard to reach jobs.

Follow the order of the flashing lines for each required measurement.

Note: For accurate measurements the instrument's position must be held constant. For example, note the position of your hand when taking first measurement. Do not move your hand when preparing to take the second measurement. Simply pivot your wrist (keeping instrument in same position) to align the next target. Then record next measurement.

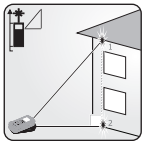

First Press for Single
Pythagoras
Calculates distance between
Point 1 and Point 2

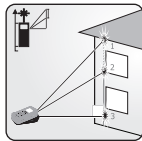

Second Press for Double
Pythagoras (Summary)
Calculates distance between
Point 1 and Point 3

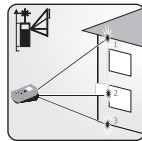

Third Press for Double
Pythagoras (Partial Measurement)
Calculates distance between
Point 1 and Point 2

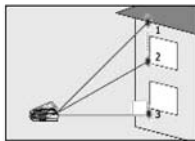
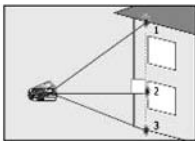
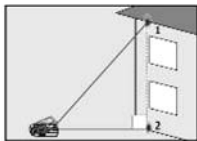





Indirect Measurement 1 (2 shot measurements FULL Height)

Press and release  Indirect Measure button once to enter mode.

Position instrument by observing flashing line on screen. (Base of triangle)

Press and release  Measure button to record first measurement.

Hold instrument position and pivot to aim laser at second target observing flashing line on screen.

Press and release  Measure button to record second measurement.

Pythagoras calculation (full height) will be presented in main screen position at bottom.

Indirect Measurement 2 (3 shot measurements FULL Height)

Press and release  Indirect Measure button twice to enter Mode.

Aim laser at target-observe flashing lines on screen.

Press and release  Measure button to record first measurement.

Hold instrument position and pivot to aim laser at second target observing flashing line on screen.

Press and release  Measure button to record second measurement.

Hold instrument position and pivot to aim laser at third target.

Press and release  Measure button to record third measurement.

Pythagoras calculation (full height) will be presented in main screen position bottom.







Indirect Measurement 3 (3 shot measurements PARTIAL Height)

Press and release  Indirect Measure button three times to enter mode.

Aim laser at targeted measuring surface observe flashing line on screen.

Press and release  Measure button to record first measurement.

Hold instrument position and pivot to aim laser at second target observing flashing line on screen.

Press and release  Measure button to record second measurement.

Hold instrument position and pivot to aim laser at third target.

Press and release  Measure button to record third measurement.

Pythagoras calculation (partial height) will be presented in main screen position at bottom.

Note: Unit of measure for each Pythagoras function is capable of being displayed in decimal (feet, inches or metric) or inches and feet to 1/32.

Simply press and hold  to scroll through each unit of measure.

To tally (or sum) the Indirect measurement calculations of multiple rooms use the following steps:

Suggestions:

Be sure you have the desired unit of measure selected.

For better visibility press and hold the backlight button  to activate the backlight.

It is recommended that you test this function prior to taking important measurements. Simply write down each Indirect measurement calculation on a piece of paper and add (or subtract) the Indirect measurement calculations along with the Laser Distance Measure. This will familiarize you with the process of how the calculations are determined.





Follow the Indirect measurement instructions above to enter Indirect measurement mode.

Once the first Indirect measurement calculation is taken it will be displayed in the bottom row on the LCD screen.

Press and release the \oplus/\cup button.

Upon pressing the \oplus/\cup button the LCD screen will be cleared however the Indirect measurement calculation is stored.

The Indirect measurement mode will remain active on the LCD screen .

Take the second Indirect measurement.

When the Indirect measurement calculation appears in the bottom row press and release the \oplus/\cup button again.

You will now see the previous Indirect measurement calculation at the top row being added to the most recent Indirect measurement calculation in the middle row.

The sum of both Indirect measurement calculations will be displayed in the bottom row.

Follow this sequence to continue tallying additional Indirect measurement dimensions.

To subtract an Indirect measurement simply press and release the $\otimes/-$ button during the sequence and that value will be deducted from the total.











Stake-out

Stake-out mode is designed to mark off repetitive equal distances. For example, fence post installation or framing.





1. To use Stake-out, you have to set one value or “stake” in memory.
2. Turn the unit on.
3. Press and release  three times to enter the first stake setting.
4. Press  to increase your value.
5. Press  to decrease your value.
6. Hold  for two seconds to shift to positions.
7. Once value is set, press  to enter.

Enter Continuous Measuring Mode by pressing and holding . An arrow will guide direction. This function can be stopped by pressing the red power button .

Memory Recall

This instrument stores your last 20 measurements in order recognizing their unit of measure and measuring mode.

Press and hold the  button.

Press  or  buttons to scroll up or down through the recorded measurements.



Backlight

Press and hold the  button for two seconds to activate backlight. Repeat this step to turn off backlight.

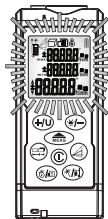

Indoor & Outdoor Measurements

This model is designed to take measurements indoors under normal settings. The measuring surfaces and ambient light are critical factors to the quality of measurement (indoors and outdoors). Outdoor measurement capability may be limited due to sunlight/UV ray interference. Please note that in some situations the unit may have difficulty reading the surface you try to measure if lighting or sunlight is intense and/or the surface being measured does not reflect the laser beam appropriately.



Measurement Errors

Error messages will appear if the unit's receiver is not getting a sufficient laser return signal.

Common surfaces that could cause an error reading:

- Water or other fluids
- Translucent to clear surfaces like glass or acrylic
- Porous or dark surfaces may require longer reading times or cause an error reading
- Moving surfaces or objects such as curtains
- Highly reflective or angled surfaces may deflect the laser beam signal

Error Codes

Code Description

Err01 Distance is outside of measuring range

Err02 Reflected signal is too weak

Err03 Out of display range

Err04 Pythagorean theorem calculation error

Err05 Low Battery

Err06 Temperature is outside of working range

Err07 Ambient light is too strong

Solution

Measure in a shorter distance or longer distance

Measure a better surface

Maximum Value: 99,999
Split up measurement area into smaller segments.

Check and verify value or the sequence of measurements is correct

Install a new battery

Measure in an environment within specified working temperature range

Measure in a darker place (shadow target)





Tips from the Pro's

Take more than one measurement in critical situations where accuracy needs to be greater than an estimation measurement. Take 3-4 measurements from the same position to compare consistency of each reading. Prior to important measurements verify that the instrument is in proper working order and take sample measurements to of a known distance to verify accuracy.

To accurately measure from the rear of the instrument, use a scrap piece of drywall or other flat material. Extend the material off the corner and butt the LDM up to the material. Then take measurement.

Place a white sheet of paper over the targeted measuring surface if error message Err02 occurs to improve the return signal.



7. Technical Specifications

Measure Range*	2" - 230'
Accuracy*	± 1/16"
Measure Speed*	0.5 seconds
Laser Type	650 nm, ± 10nm, Class II, ≤ 1mW
Power Supply	2 - "AA" Alkaline Batteries (included)
Battery Life	10,000 measurements
Dimensions	4.33" x 1.77" x 1.18" (110 x 45 x 30 mm)
Working Temperature	23°F to 104°F (-5°C to +40°C)
Storage Temperature	-4°F to 140°F (-20°C to +60°C)
Auto Shut-off Laser	30 seconds
Auto Shut-off Main Power	3 minutes
IP Protection Class	54

*The working range and accuracy is dependent on how well laser light is reflected from the surface for the target and with increased brightness of the ambient light intensity measuring accuracy may deteriorate.

8. Product Warranty

Johnson Level & Tool offers a two year limited warranty on our laser distance measure products. You can obtain a copy of the limited warranty for a Johnson Level & Tool product by contacting Johnson Level & Tool's Customer Service Department as provided below or by visiting us online at www.johnsonlevel.com. The limited warranty for each product contains various limitations and exclusions.

NOTE: The user is responsible for the proper use and care of the product.

For further assistance, or if you experience problems with this product that are not addressed in this instruction manual, please contact our Customer Service Department.

In the U.S., contact Johnson Level & Tool's Customer Service Department at 888-9-LEVELS.

In Canada, contact Johnson Level & Tool's Customer Service Department at 800-346-6682.



9. Product Registration

Enclosed with this instruction manual you will find a warranty registration card to be completed for your product. You will need to locate the serial number for your product that is located inside the battery compartment. **PLEASE NOTE THAT IN ADDITION TO ANY OTHER LIMITATIONS OR CONDITIONS OF JOHNSON LEVEL & TOOL'S LIMITED WARRANTY, JOHNSON LEVEL & TOOL MUST HAVE RECEIVED YOUR PROPERLY COMPLETED WARRANTY CARD WITHIN 30 DAYS OF YOUR PURCHASE OF THE PRODUCT OR ANY LIMITED WARRANTY THAT MAY APPLY SHALL NOT APPLY AND THERE SHALL BE NO WARRANTY.**



